

**Laminate** Your Name \_\_\_\_\_  
 Purchase \_\_\_\_\_  
 Order Tag \_\_\_\_\_  
 Notes \_\_\_\_\_

Material in a box \_\_\_\_\_ sq. ft.  
 Plank width \_\_\_\_\_ inch  
 Required by \_\_\_\_\_

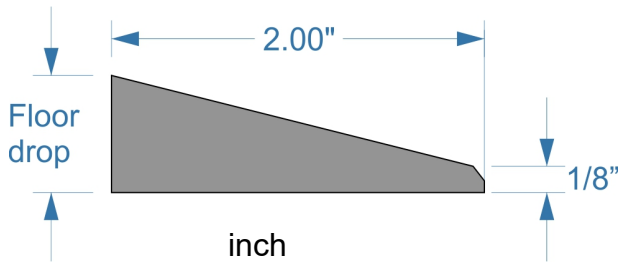

**LR - Reducer, Flush**

Length, "	Quantity
	x
	x
	x
Total	LF

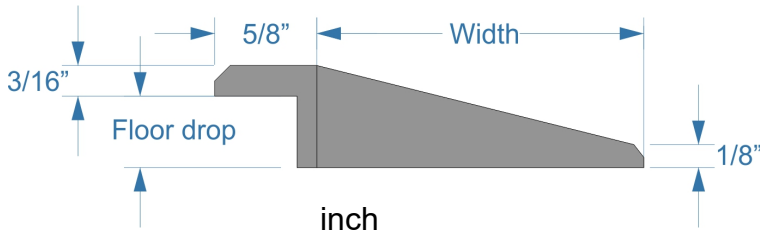

**LRO - Reducer, Overlap**

Length, "	Quantity
	x
	x
	x
Total	LF

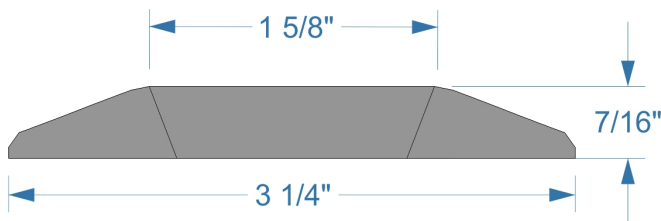

**LTH - Threshold**

Length, "	Quantity
	x
	x
	x
Total	LF

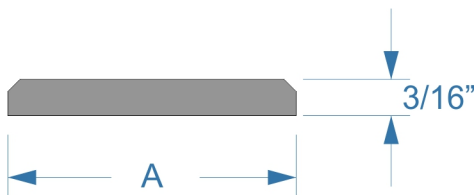

**LEC - End Cap**

Length, "	Quantity
	x
	x
	x
Total	LF

**Laminate**

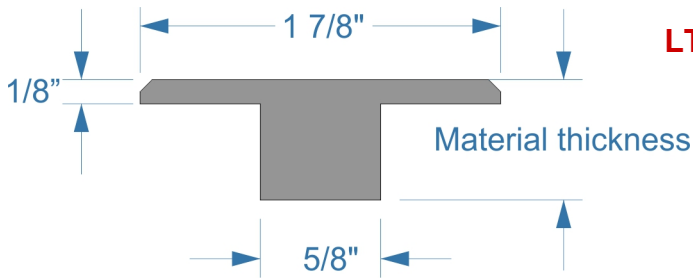

**LTML - T-mould, Large**

Length, "	Quantity
	x
	x
	x
Total	LF

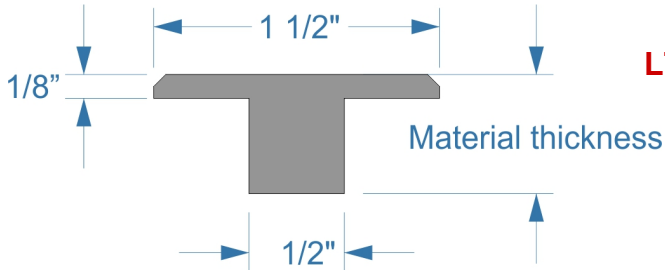

**LTMS - T-mould, Small**

Length, "	Quantity
	x
	x
	x
Total	LF

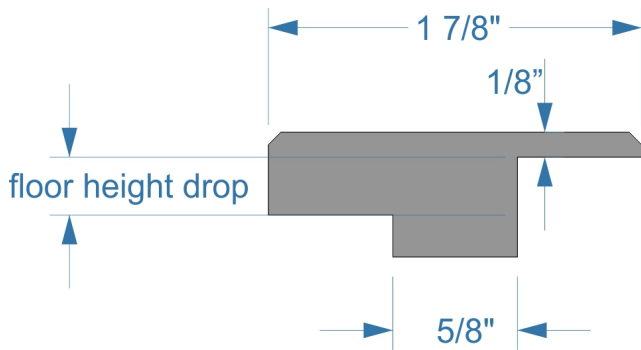

**LTMU - T-mould, Uneven**

Length, "	Quantity
	x
	x
	x
Total	LF

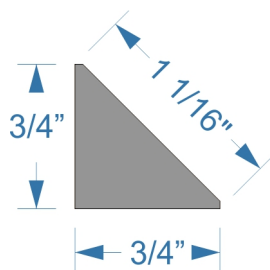

**LIC - Inside Corner**

Length, "	Quantity
	x
	x
	x
Total	LF